

Common Mode Choke

CHOK3216 SERIES

PRODUCT CATALOG



寶仁弘電子有限公司 Prosperity Electronic Co., Limited

EML: brh@baorenhong.com Web: www.baorenhong.com

TEL: 0755-29687188 FAX: 0755-29688152

深圳市寶安區福永鎮立新二路天佑創客產業園

TEL: 0512-36878535 FAX: 0512-36878435

江蘇省昆山市花橋鎮綠地大道1325號

Common Mode Choke

◎ Product introduction 產品介紹

- Excellent solderability and heat resistance for either flow or reflow soldering

良好的可焊性和耐焊性

- High common mode impedance at high frequency

高頻下有較高共模阻抗

- Excellent noise suppression performance

良好的噪聲抑制性能

- Terminal electrode has been electroplated, suitable flow soldering, reflow soldering an arbitrary welding method

端子電極已經過電鍍，可適用流動焊接，回流焊接任意一種焊接工法

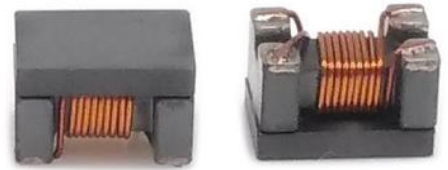

◎ Product application 產品應用

- Ideally used in digital TVS, DVD recorders and liquid crystal projectors PCS.USD2.0、IEEE1394 connected local area network interface.

用於數字電視、DVD和液晶投影機及個人計算機及USB2.0，IEEE1394等局域網接口。

◎ Product Identification 產品標識

CHOK 3216 S 222 T

CHOK-----Series name 系列名稱

3216-----Dimension 產品尺寸

S-----Material code 材料代碼

222-----Impedance 阻抗值【222=2200Ω】

T-----Taping 編帶盤裝

SMD Common Mode Chocke

◎Shape&Dimensions 形狀與尺寸:

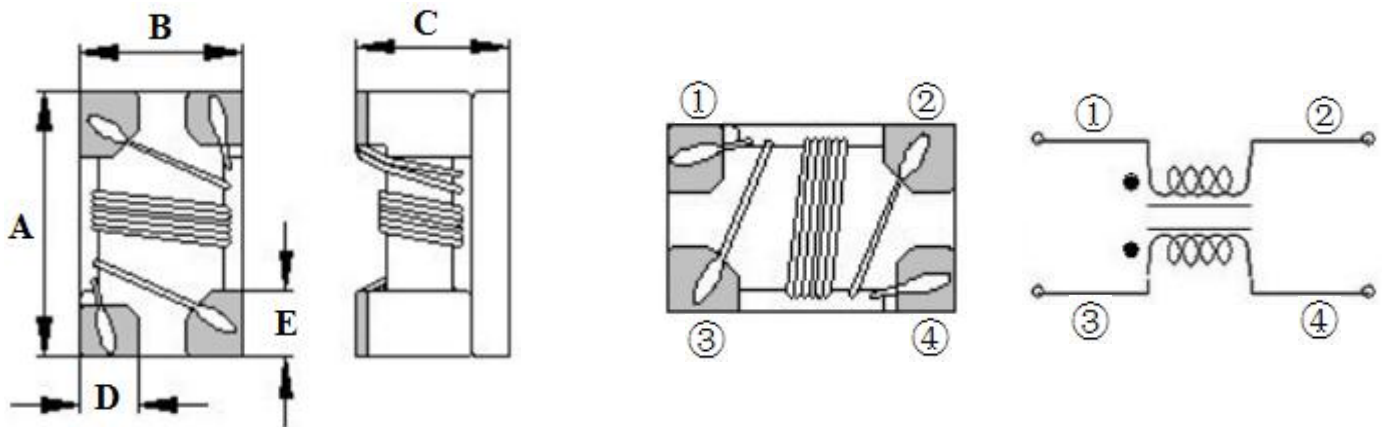

unit:mm

PART NAUMBER	A	B	C	D	E	CHIPS REEL
1210	1.2±0.20	1.0±0.30	1.0±0.30	0.38 Typ	0.36 Typ	4K
2012	2.0±0.20	1.2±0.20	1.2±0.20	0.40 Typ	0.45 Typ	3K
3216	3.2±0.20	1.6±0.20	2.0±0.20	0.60 Typ	0.60 Typ	2K
3225	3.2±0.20	2.5±0.20	2.2±0.20	0.90 Typ	0.80 Typ	2K
4525	4.8±0.20	2.8±0.20	2.2±0.20	0.75 Typ	0.75 Typ	2K
4528/4532	4.5±0.20	3.2±0.20	2.8±0.20	1.00 Typ	1.00 Typ	0.5K

◎Recommender Land Pattern 推薦焊盤布局:

unit:mm

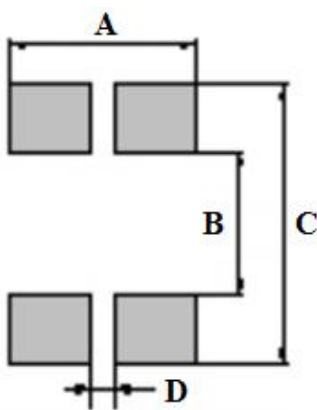

PART NAUMBER	A	B	C	D
1210	1.20 Typ	0.60 Typ	1.50 Typ	0.30 Typ
2012	1.20 Typ	0.80 Typ	2.60 Typ	0.40 Typ
3216	1.60 Typ	1.60 Typ	3.70 Typ	0.40 Typ
3225	3.50 Typ	1.60 Typ	4.40 Typ	0.60 Typ
4525	2.95 Typ	3.50 Typ	6.00 Typ	1.05 Typ
4528/4532	3.60 Typ	2.10 Typ	4.90 Typ	0.40 Typ

SMD Common Mode Chocke

© Detailed specifications and parameters are introduced

詳細規格及參數介紹

ORDERING CORE	Impedance (Ω)	Test Frequency (MHz)	DC Resistance (Ω)MAX	Rated Current (mA)MAX
CHOK3216S330T	33 \pm 25%	100	0.200	400
CHOK3216S500T	50 \pm 25%	100	0.250	400
CHOK3216S900T	90 \pm 25%	100	0.300	400
CHOK3216S121T	120 \pm 25%	100	0.300	400
CHOK3216S161T	160 \pm 25%	100	0.400	350
CHOK3216S221T	220 \pm 25%	100	0.450	300
CHOK3216S261T	260 \pm 25%	100	0.500	310
CHOK3216S501T	500 \pm 25%	100	0.800	260
CHOK3216S601T	600 \pm 25%	100	0.800	260
CHOK3216S102T	1000 \pm 25%	100	1.000	250
CHOK3216S222T	2200 \pm 25%	100	1.200	200

SMD Common Mode Chocke

◎ Test curve of reference as follows

測試曲線參考如下：

COMMON MODE NORMAL MODE

CHOK3216S330T

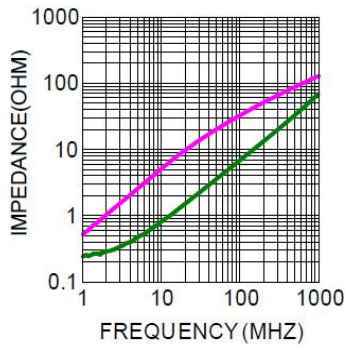

CHOK3216S500T

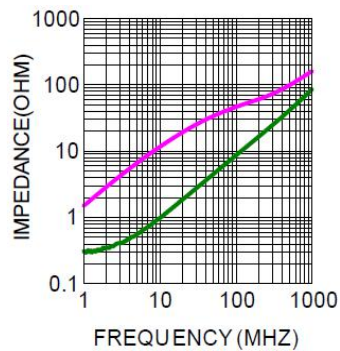

CHOK3216S900T

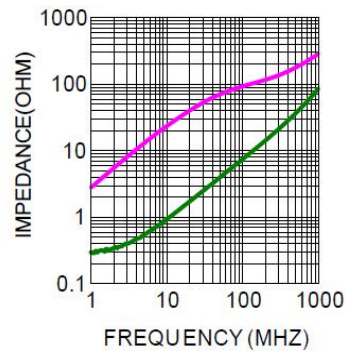

CHOK3216S121T

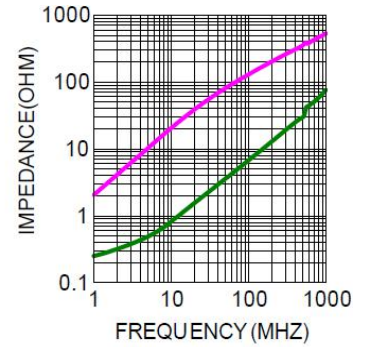

CHOK3216S161T

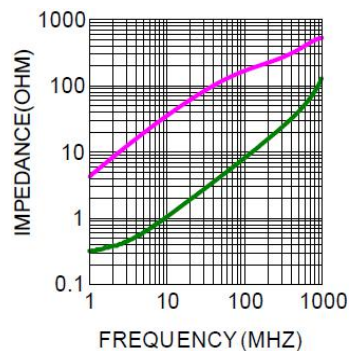

CHOK3216S221T

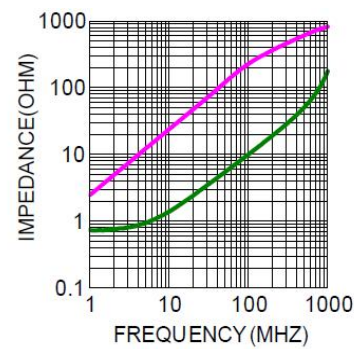

CHOK3216S261T

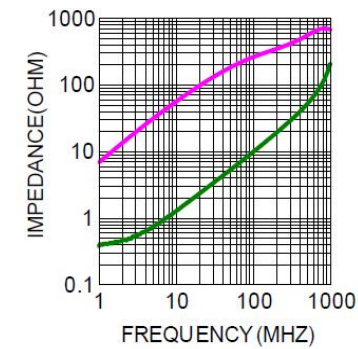

CHOK3216S501T

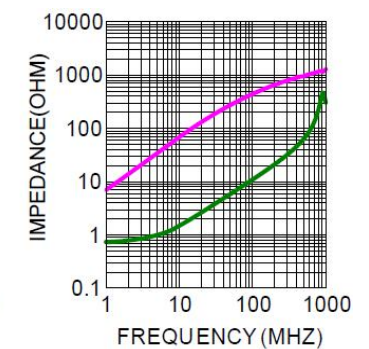

CHOK3216S601T

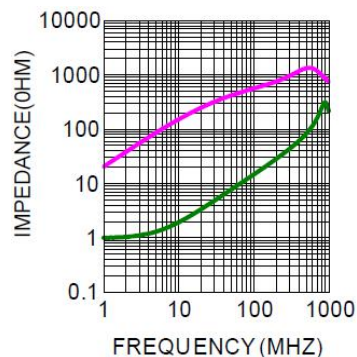

CHOK3216S102T

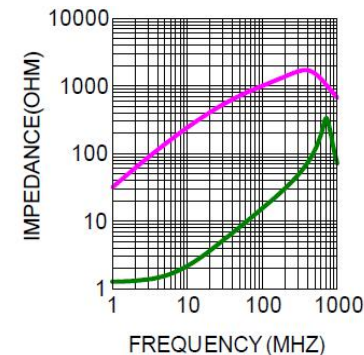

CHOK3216S222T

