

# Common Mode Choke

## CHOK-E SERIES

## PRODUCT CATALOG



寶仁弘電子有限公司 Prosperity Electronic Co., Limited

EML: brh@baorenhong.com Web: www.baorenhong.com

TEL: 0755-29687188 FAX: 0755-29688152

深圳市寶安區福永鎮立新二路天佑創客產業園

TEL: 0512-36878535 FAX: 0512-36878435

江蘇省昆山市花橋鎮綠地大道1325號

# SMD Common Mode Chocke

## ◎Shape&Dimensions 形狀與尺寸:

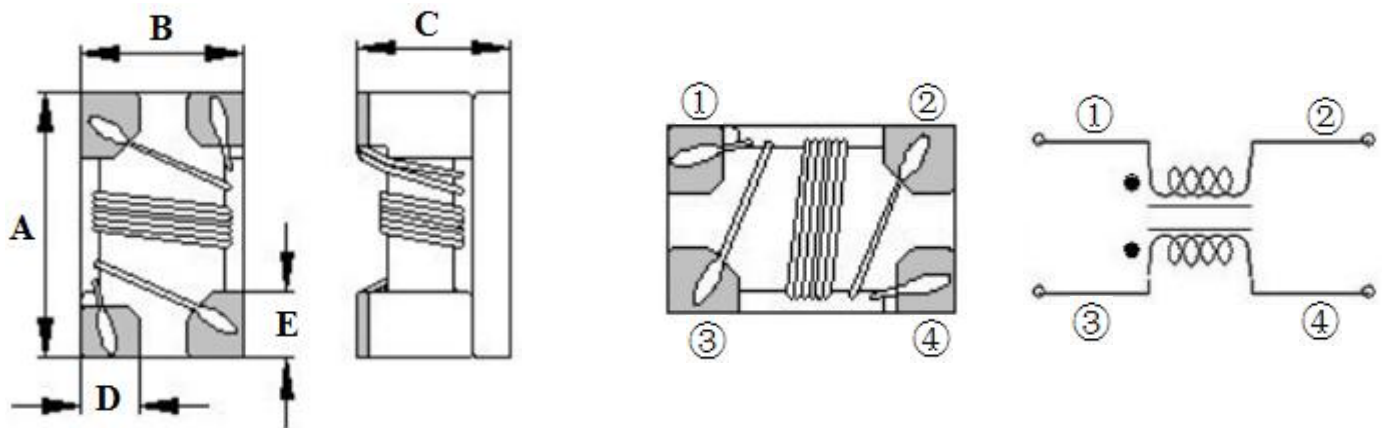

unit:mm

PART NAUMBER	A	B	C	D	E	CHIPS REEL
3225	3.2±0.20	2.5±0.20	2.2±0.20	0.90 Typ	0.80 Typ	2K
4528	4.5±0.20	3.2±0.20	2.8±0.20	1.00 Typ	1.00 Typ	0.5K

## ◎Recommender Land Pattern 推薦焊盤布局:

unit:mm

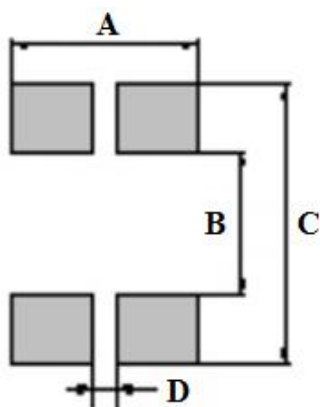

PART NAUMBER	A	B	C	D
3225	3.50 Typ	1.60 Typ	4.40 Typ	0.60 Typ
4528	3.60 Typ	2.10 Typ	4.90 Typ	0.40 Typ

# SMD Common Mode Chocke

© Detailed specifications and parameters are introduced

詳細規格及參數介紹

ORDERING CORE	Inductance( $\mu$ H) +50%/-30% at 100KHz/0.1V	Impedance( $\Omega$ ) at 10MHz		DC Resistance ( $\Omega$ )MAX	Rated Current (mA)MAX	Rated Volt. (Vdc)MAX	IR( $\Omega$ ) MIN
		MIN.	TYP.				
CHOK3225S110E	11	300	550	0.4	300	80	10M
CHOK3225S220E	22	500	1100	0.5	300	80	10M
CHOK3225S510E	51	1000	2600	0.7	200	80	10M
CHOK3225S101E-Q	100	2200	5100	1.5	150	80	10M
CHOK4528S110E-Q	11	300	600	0.6	360	50	10M
CHOK4528S220E-Q	22	500	1200	1	310	50	10M
CHOK4528S510E-Q	51	1000	2800	1	230	50	10M
CHOK4528S101E-Q	100	2000	5800	2	200	50	10M
CHOK4528S201E-Q	200 (+60%/-20%)	-		4.5	100	50	10M

# SMD Common Mode Chocke

© Test curve of reference as follows

測試曲線參考如下：

CHOK3225S110E

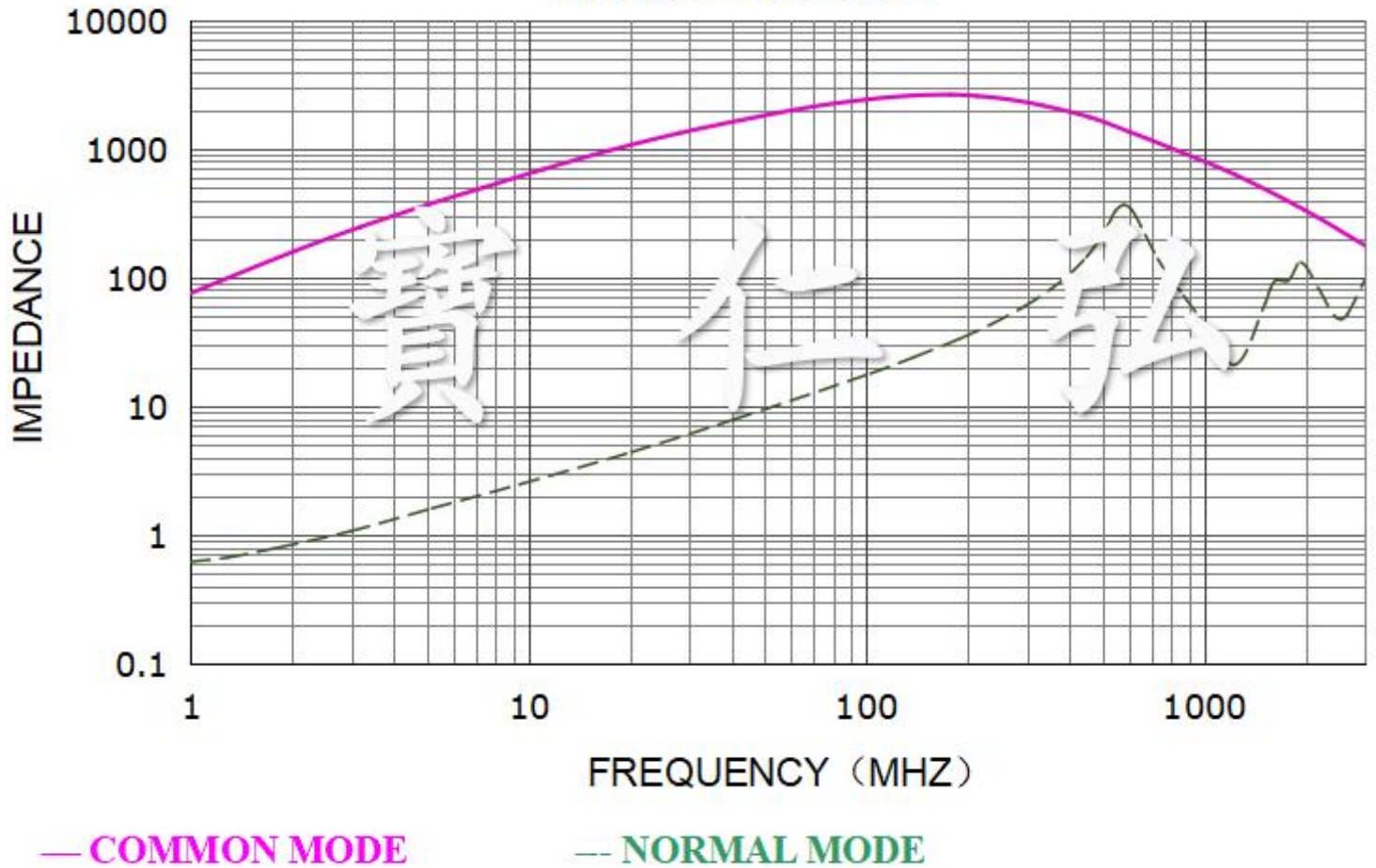

# SMD Common Mode Chocke

© Test curve of reference as follows

測試曲線參考如下：

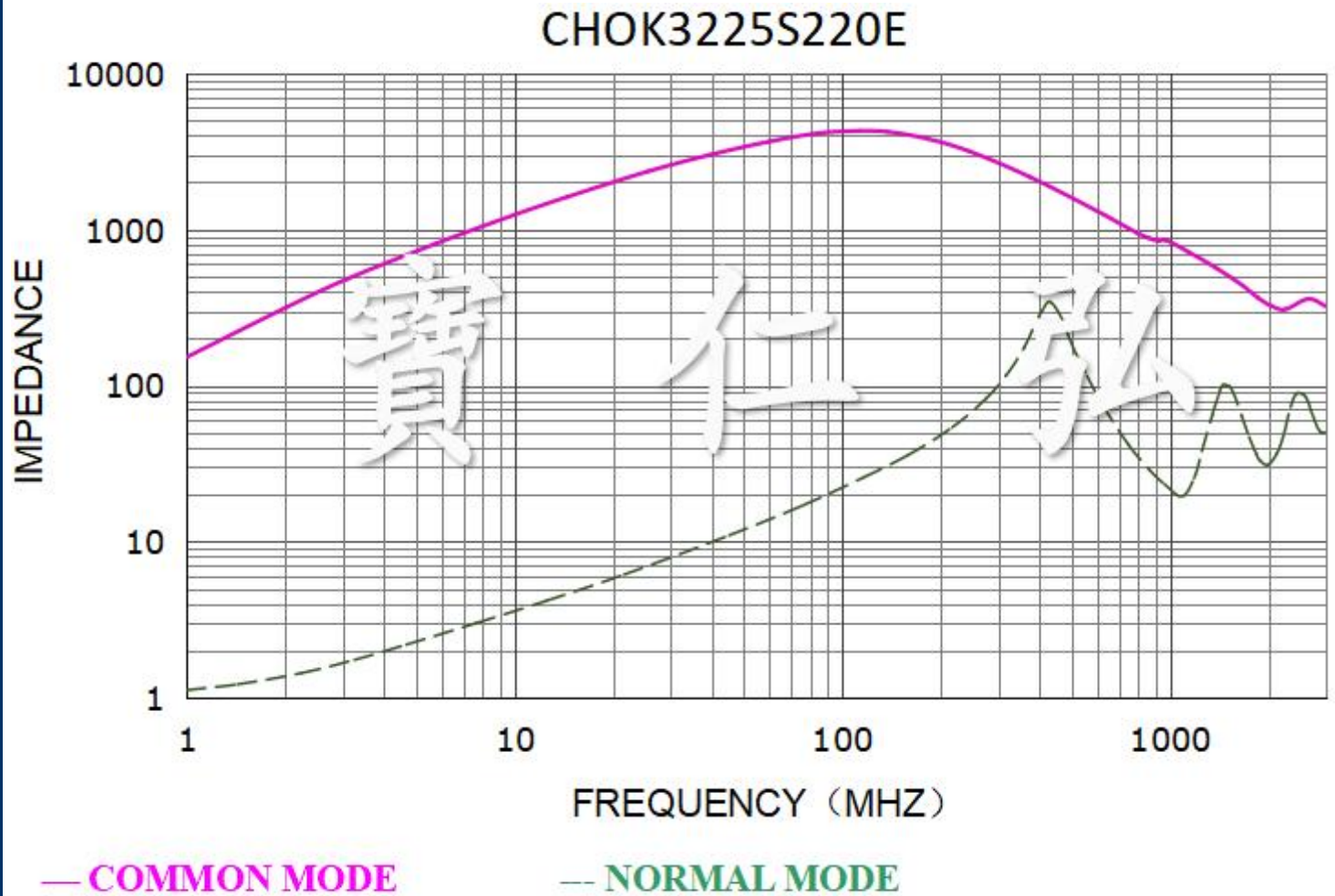

# SMD Common Mode Chocke

© Test curve of reference as follows

測試曲線參考如下：

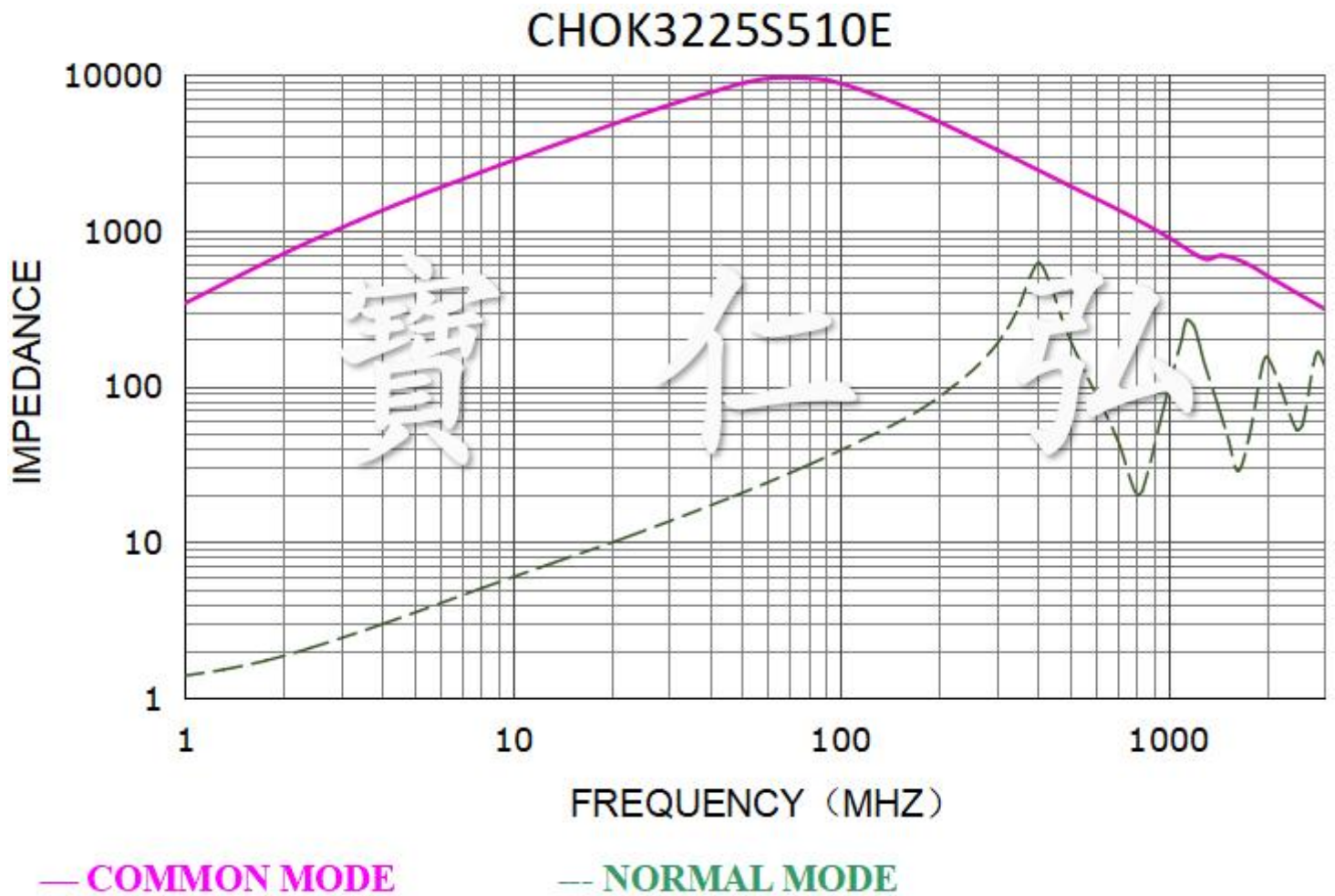

# SMD Common Mode Chocke

© Test curve of reference as follows

測試曲線參考如下：

CHOK3225S101E-Q

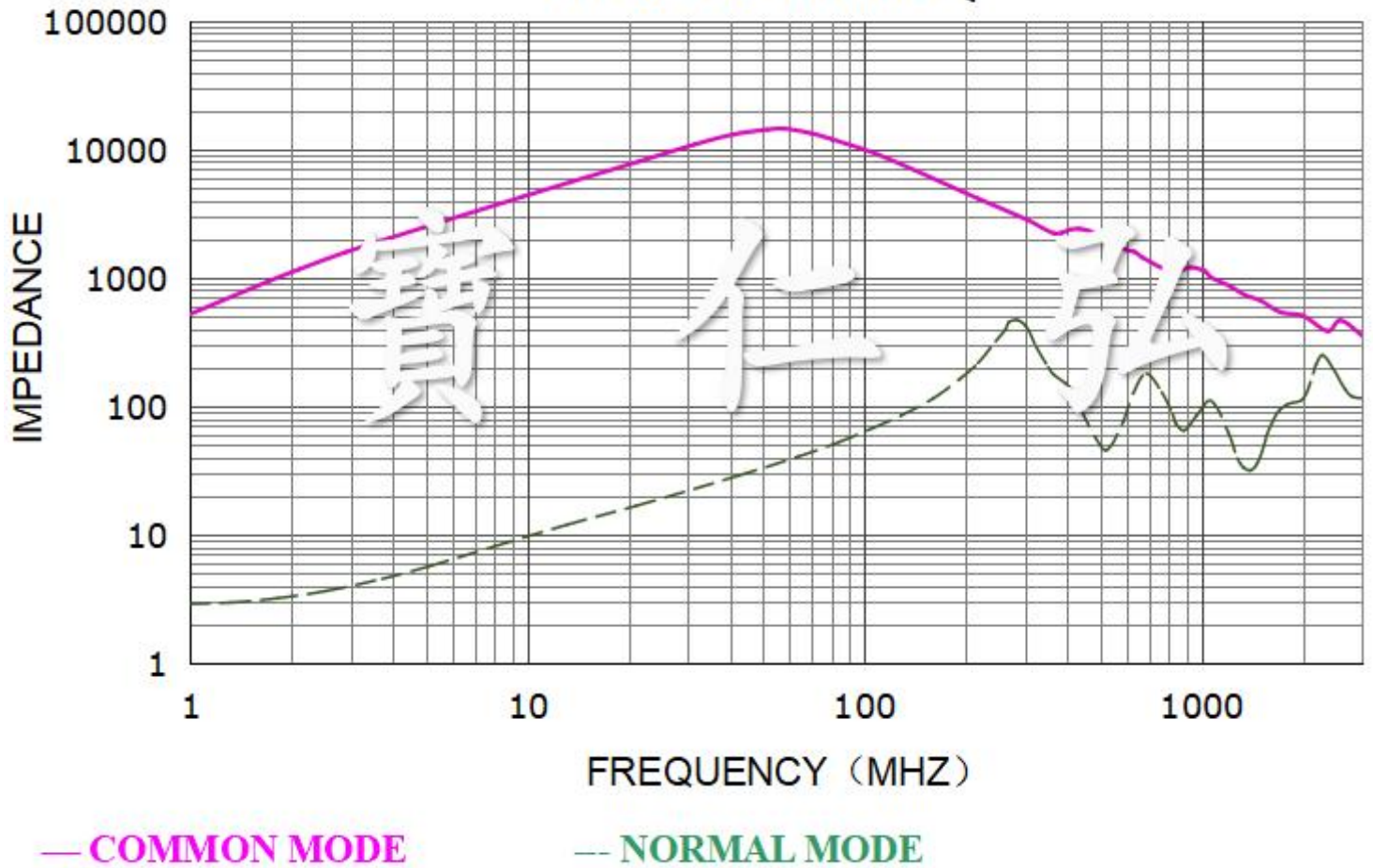

# SMD Common Mode Chocke

© Test curve of reference as follows

測試曲線參考如下：

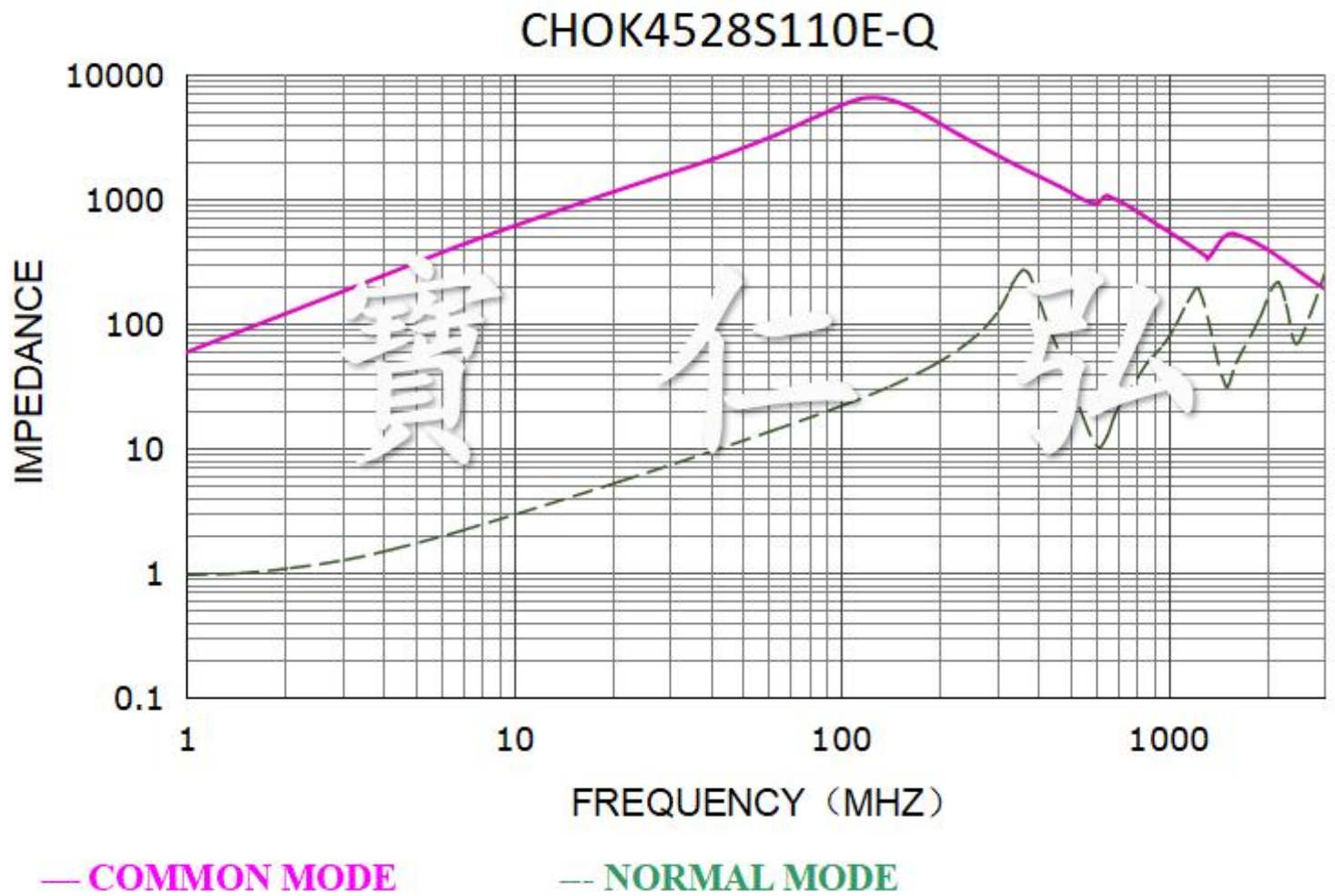



# SMD Common Mode Chocke

© Test curve of reference as follows

測試曲線參考如下：

CHOK4528S220E-Q

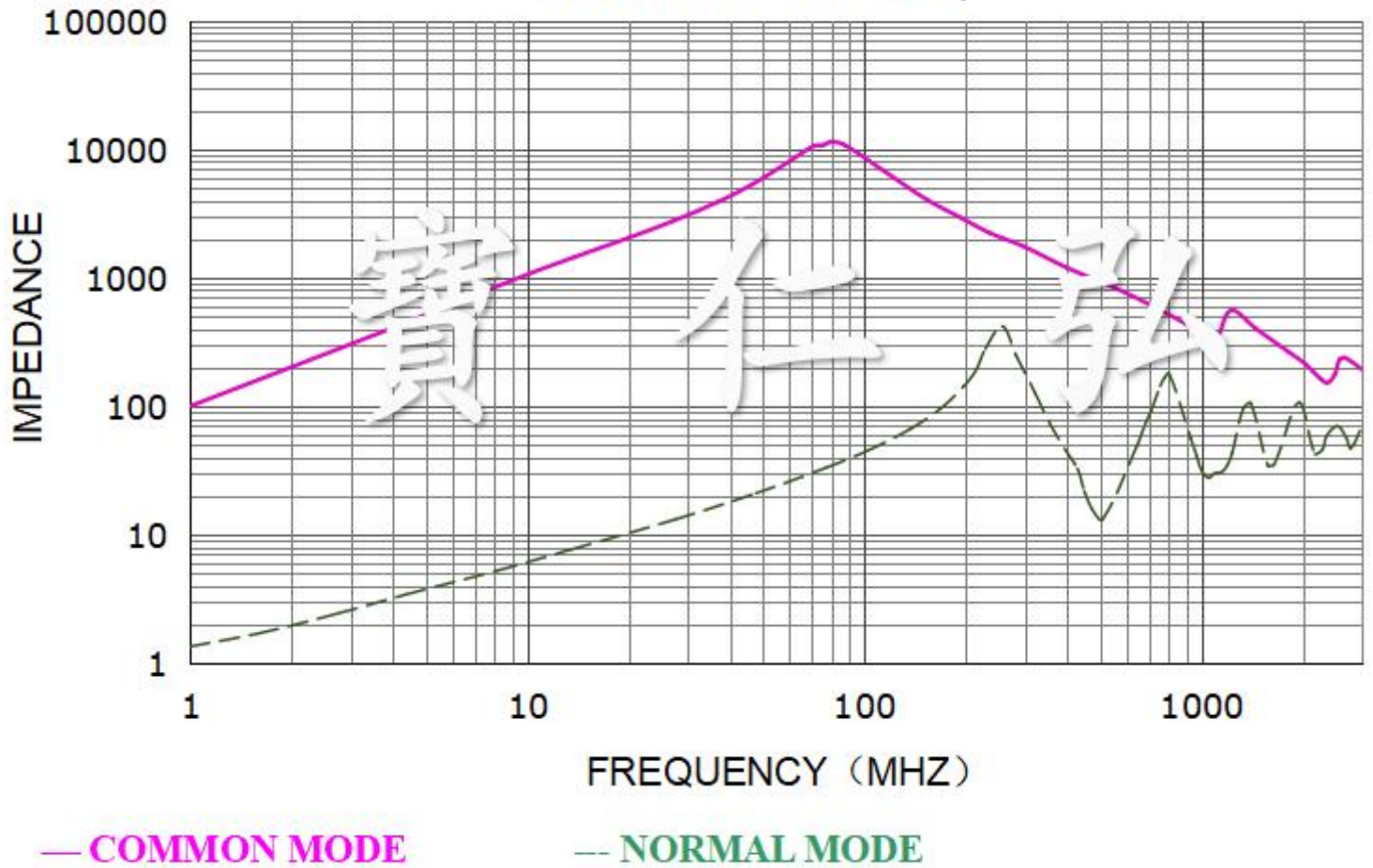

# SMD Common Mode Chocke

© Test curve of reference as follows

測試曲線參考如下：

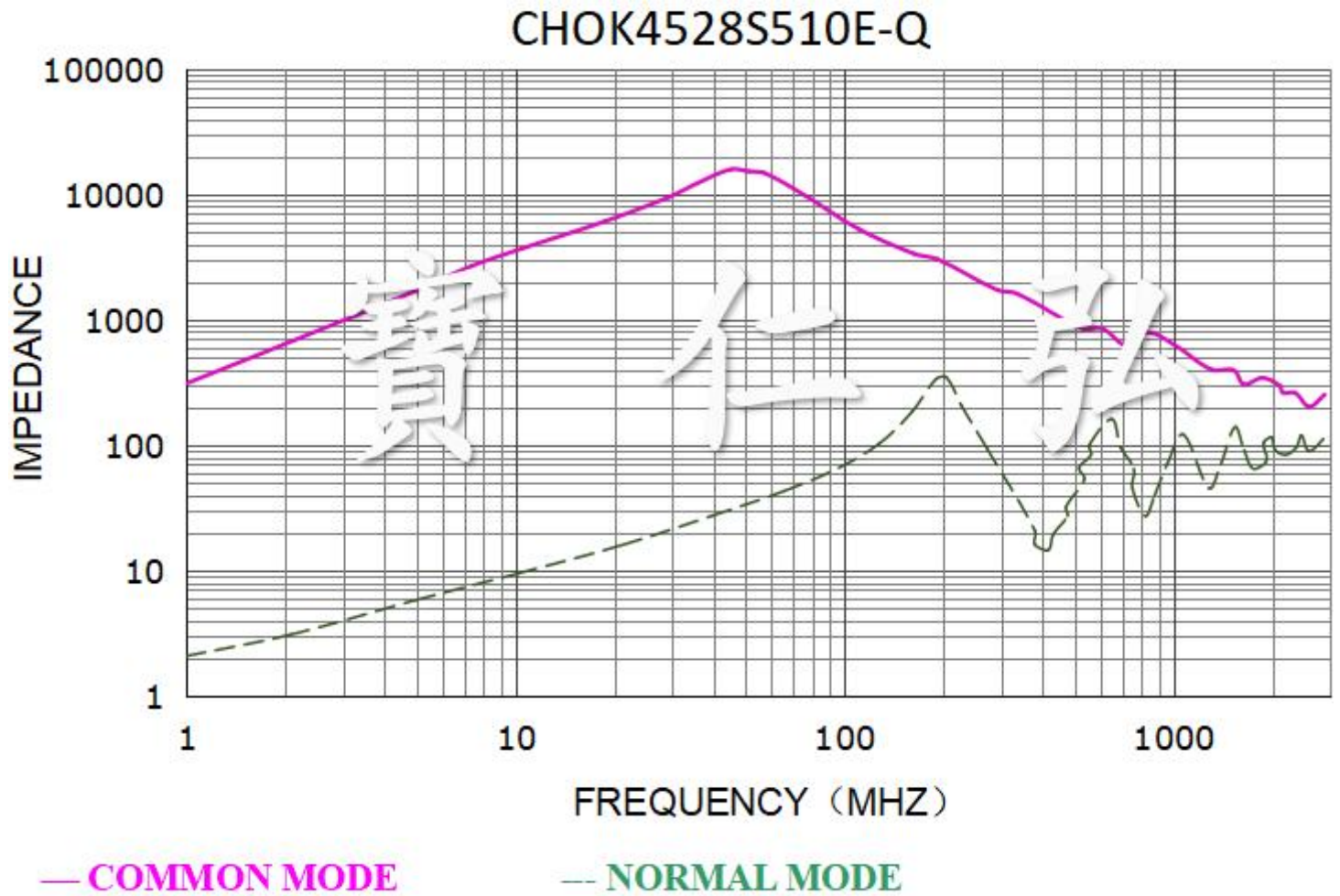

# SMD Common Mode Chocke

© Test curve of reference as follows

測試曲線參考如下：

CHOK4528S101E-Q

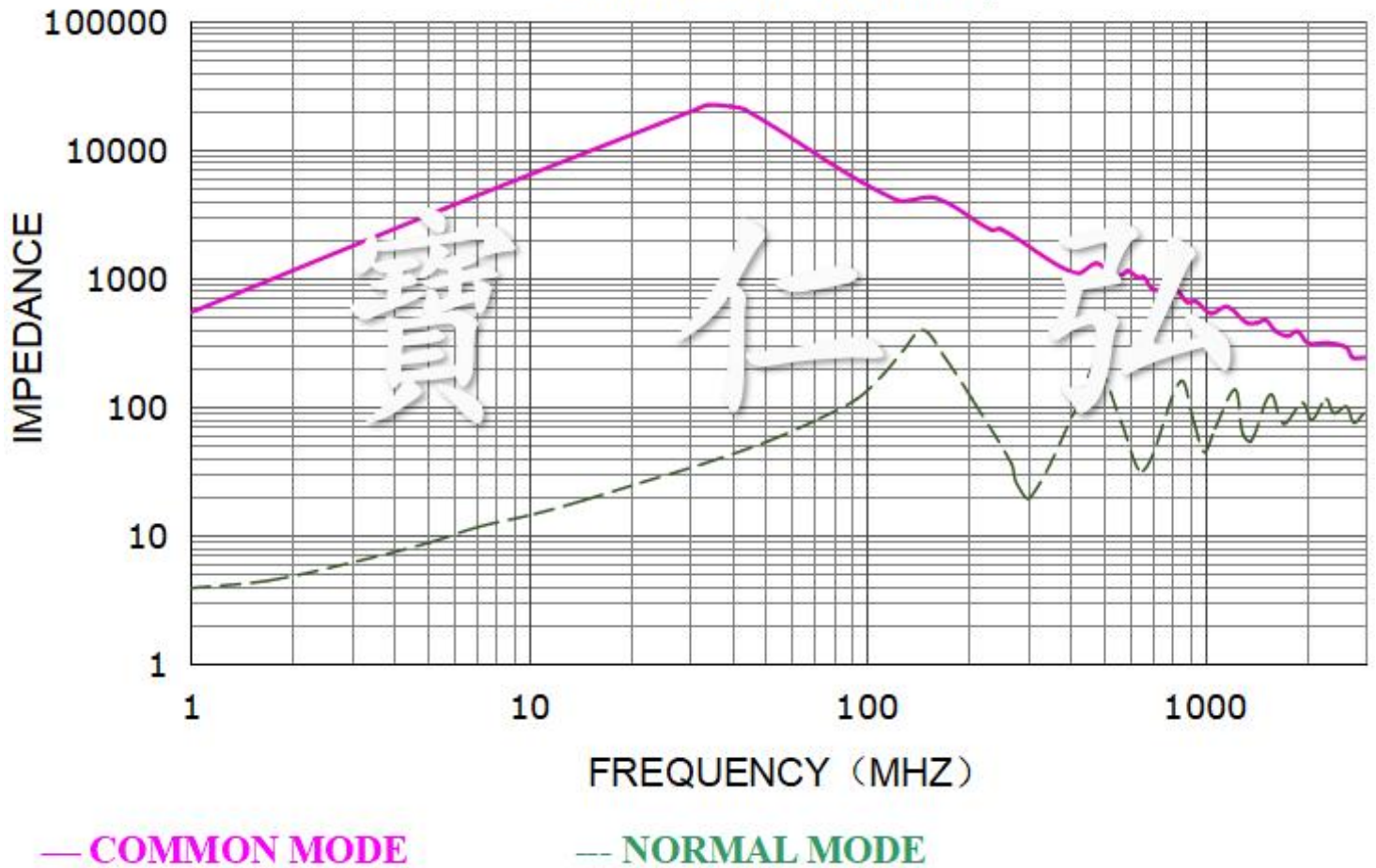

# SMD Common Mode Chocke

© Test curve of reference as follows

測試曲線參考如下：

CHOK4528S201E-Q

