

# SMD Common Mode Filter

## CMF SERIES

## PRODUCT CATALOG



寶仁弘電子有限公司 Prosperity Electronic Co., Limited

EML: brh@baorenhong.com Web: www.baorenhong.com

TEL: 0755-29687188 FAX: 0755-29688152

深圳市寶安區福永鎮立新二路天佑創客產業園

TEL: 0512-36878535 FAX: 0512-36878435

江蘇省昆山市花橋鎮綠地大道1325號

# SMD Common Mode Filter

## ◎Shape&Dimensions 形狀與尺寸:

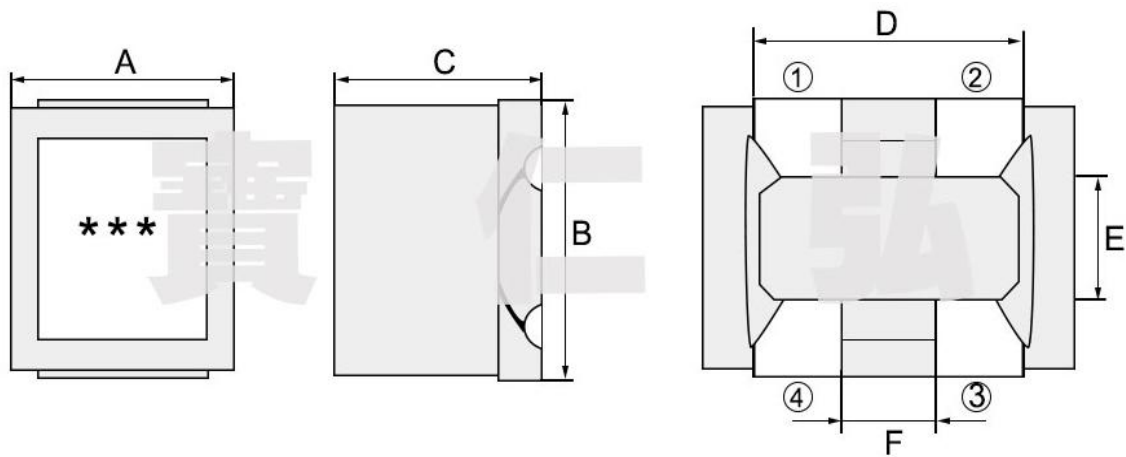

unit:mm

PART NAUMBER	A	B	C	D	E	F
5025	5.0±0.3	5.0±0.3	2.5 MAX	3.5 Typ	2.2 Typ	1.1 Typ

MPQ:2.5K

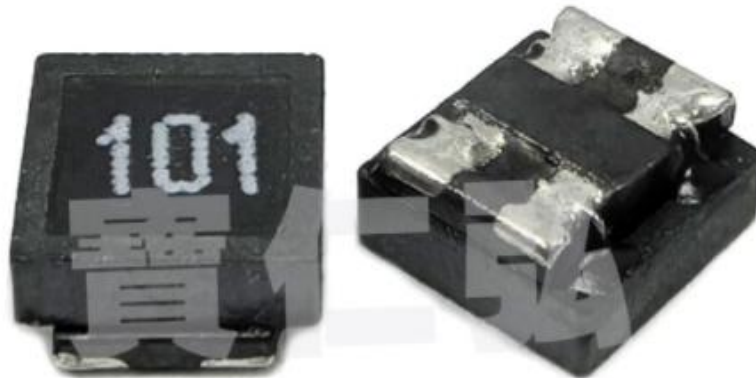

# SMD Common Mode Filter

◎Recommender Land Pattern 推薦焊盤布局:

unit:mm

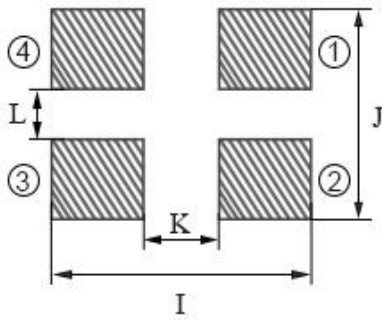

PART NAUMBER	I	J	K	L
5025	5.5 Typ	4.4 Typ	2.0 Typ	0.9 Typ

# SMD Common Mode Chocke

© Detailed specifications and parameters are introduced

詳細規格及參數介紹

ORDERING CORE	Impedance( $\Omega$ ) 100MHZ/0.5V	DC Resistance ( $\Omega$ )MAX	Rated Current (mA)MAX	Rated Volt. (Vdc)MAX	Insulation Resistance (M $\Omega$ )MIN
CMF5025-101A60T	100 $\pm$ 35%	0.015	6000	50	10
CMF5025-251A50T	250 $\pm$ 35%	0.02	5000	50	10
CMF5025-501A40T	500 $\pm$ 35%	0.03	4000	50	10
CMF5025-102A20T	1000 $\pm$ 35%	0.045	2000	50	10
CMF5025-142A15T	1400 $\pm$ 35%	0.055	1500	50	10

# SMD Common Mode Filter

© Test curve of reference as follows

測試曲線參考如下：

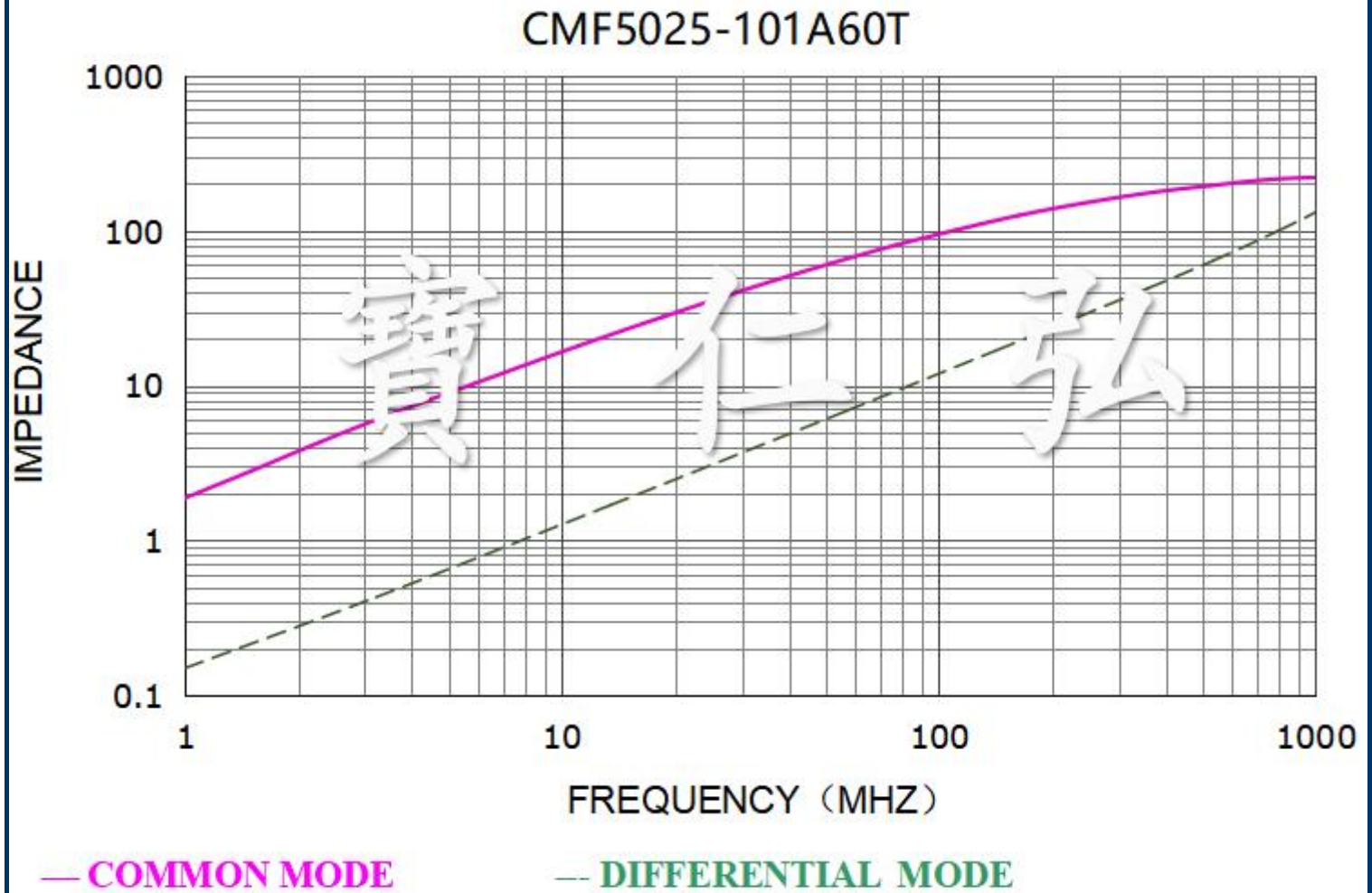

# SMD Common Mode Filter

© Test curve of reference as follows

測試曲線參考如下：

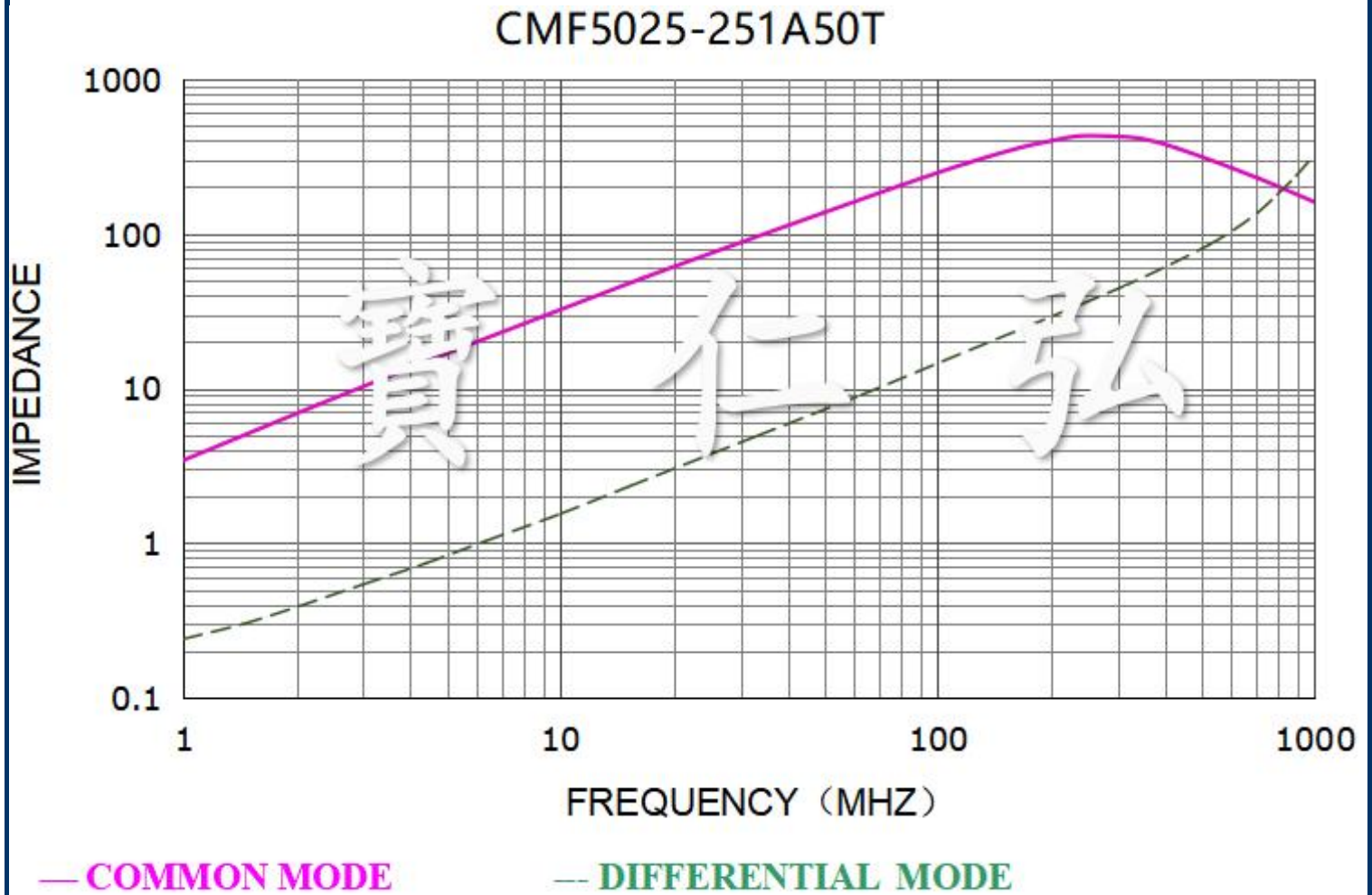

# SMD Common Mode Filter

© Test curve of reference as follows

測試曲線參考如下：

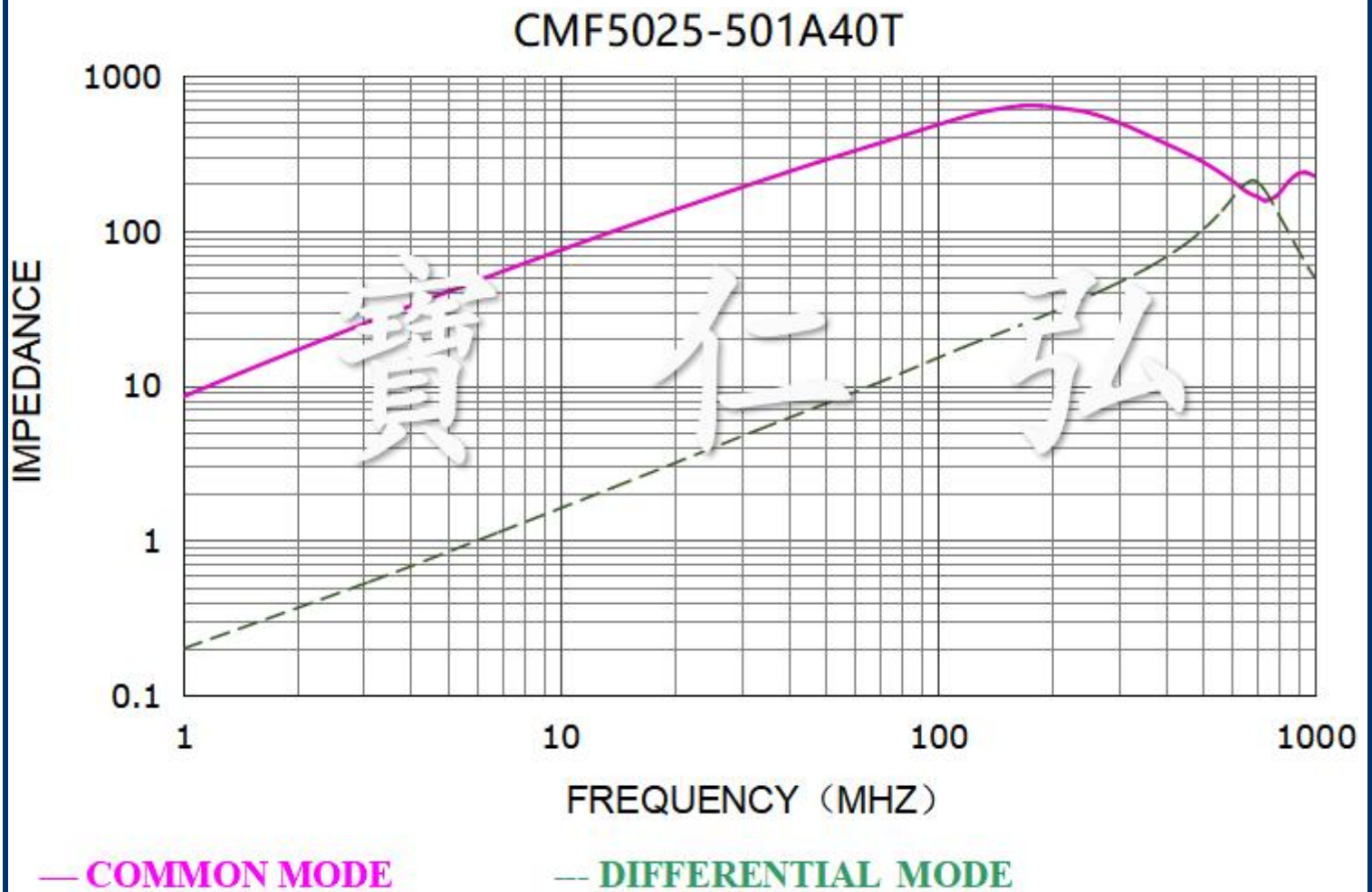

# SMD Common Mode Filter

© Test curve of reference as follows

測試曲線參考如下：

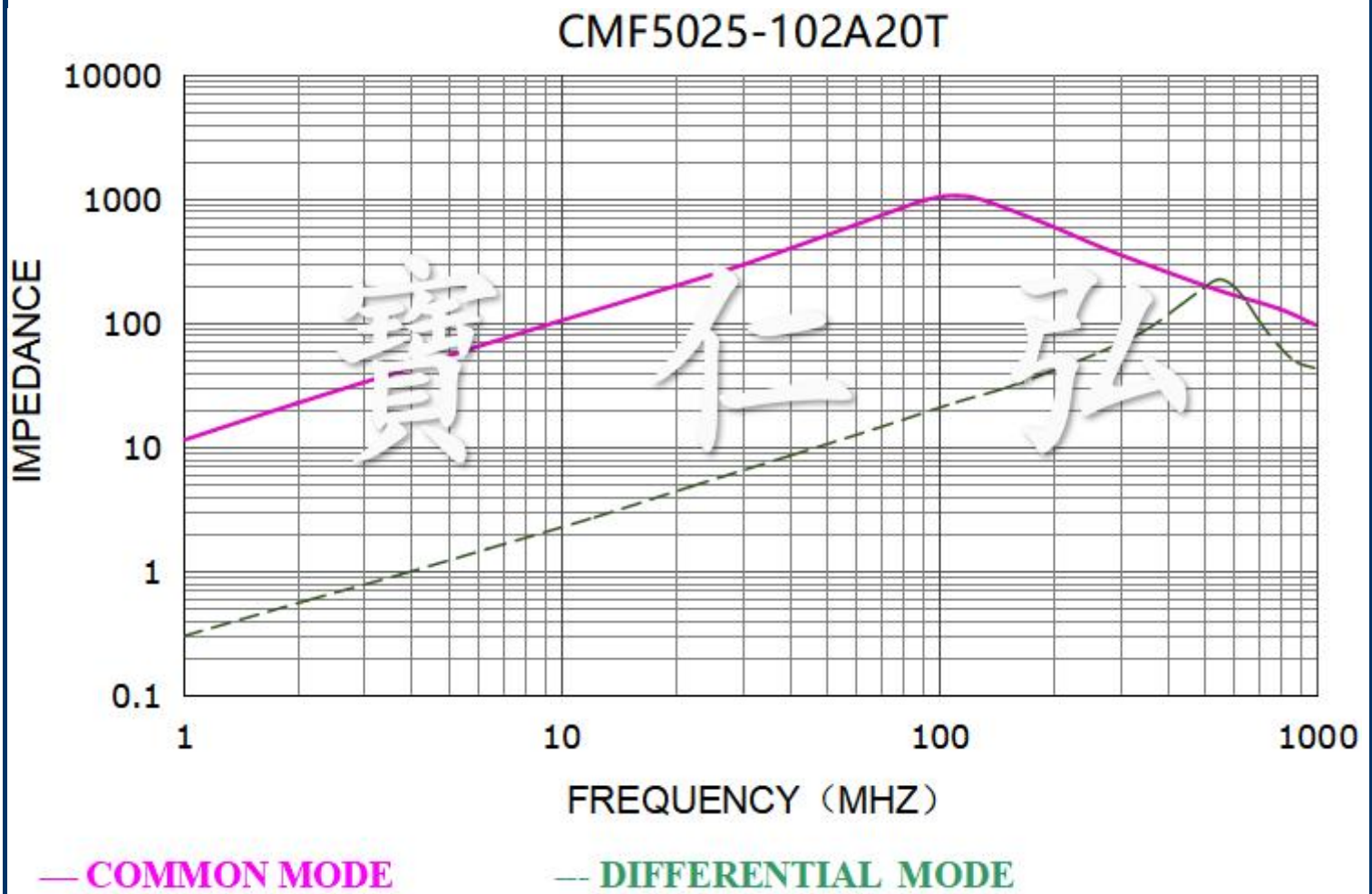



# SMD Common Mode Filter

© Test curve of reference as follows

測試曲線參考如下：

